

# VMZINC Building Principles

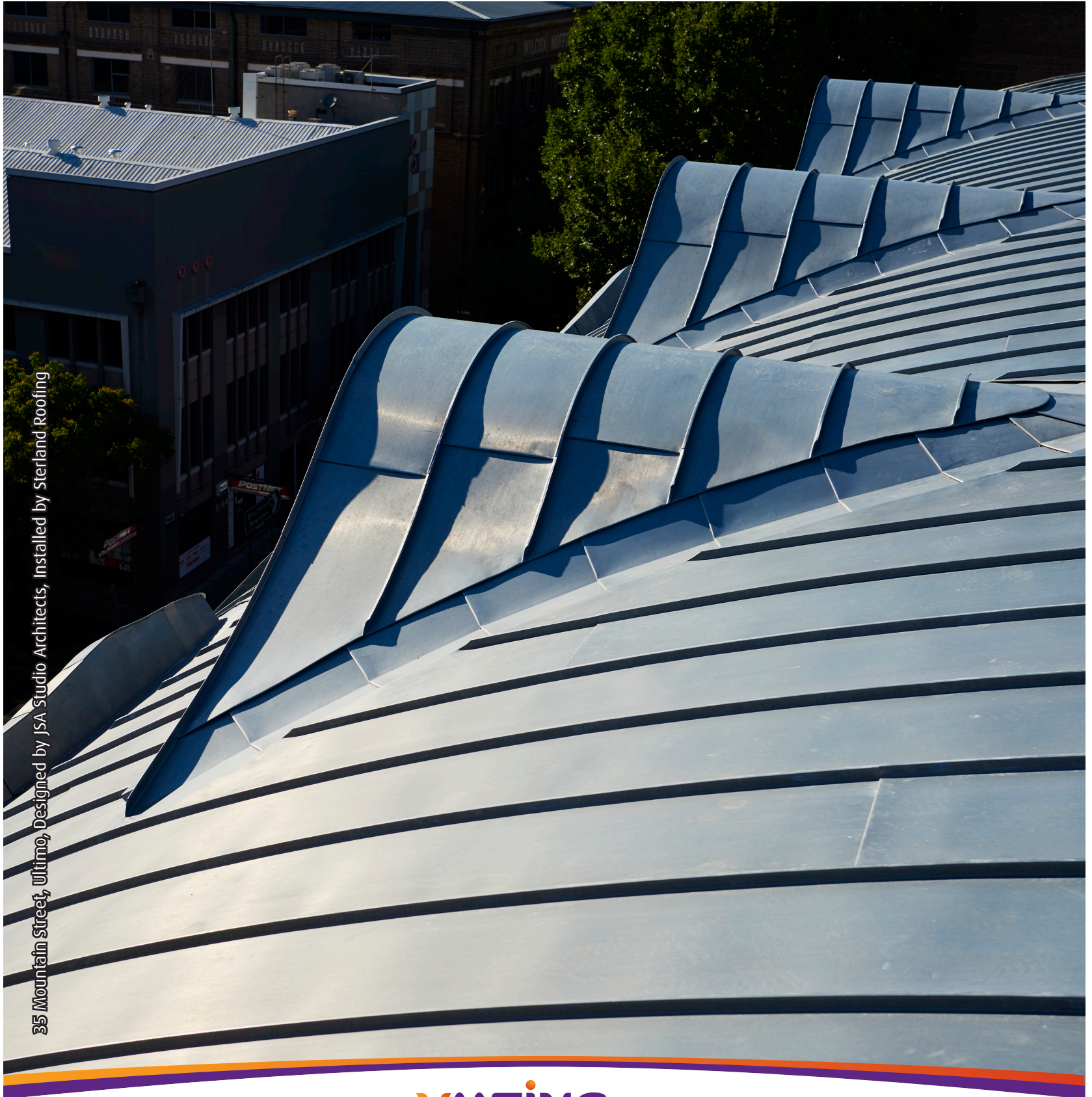

35 Mountain Street, Ultimo, Designed by JSA Studio Architects, Installed by Sterland Roofing



# VMZINC Building Principles

## Contents



4. Introduction
5. Surface Finishes
6. Ventilation rules
7. Double Lock Standing Seam roofing
8. Adeka roofing and cladding
9. Single Lock Standing Seam cladding
10. Interlocking Panel cladding
11. Flat Lock Panel cladding
12. Sine Wave cladding
13. VMZINC PLUS
- 14-15. Compatibility rules
- 16-17. Maintenance
18. Further Technical Information
19. Zinc weights and thicknesses

### Company profile

VMZINC Manufactures a wide range of rolled zinc products for use in Building Construction and has almost 2 centuries of experience. In addition to traditional façade and roofing system applications such as Standing Seam and Flat Lock Panel, the VMZINC range includes Interlocking Panels, pre-formed Adeka tiles, Composite Panel, Cassette, rainwater systems, perforated panels and ornamentation such as customised finials, dormer windows and other decorative pieces. VMZINC can also be applied to interior applications, signage and balustrades. VMZINC is now part of the Fedrus Group, and operates under VM Building Solutions offering complete solutions for roofing and facades.



VM BUILDING SOLUTIONS

# VMZINC Introduction

Zinc is among the most sustainable metals used in construction today and has been used as a building material on the roofs of Paris for almost 200 years. VMZINC have been manufacturing the highest quality rolled zinc for external roofing, wall cladding and rainwater systems since 1837, and continue to be the market innovator for surface finishes and zinc applications. VMZINC is 100% recyclable, 100% natural and extremely durable.

VMZINC is 99.995% pure zinc with the mandatory traces of Titanium, Copper and Aluminium to give mechanical strength. Zinc is non-ferrous (does not contain Iron), and will not rust with age. Zinc forms a protective external barrier on its surface upon contact with the natural components of the atmosphere. This is called the zinc 'patina' and forms upon contact with rainwater, oxygen and carbon dioxide in the atmosphere. The patina continually renews itself over time making zinc an extremely durable and low maintenance building material. In Australia a zinc roof or facade should easily last 70 to 100 years in an urban or rural environment with little to no maintenance. Other benefits of using zinc are:

- \* Extremely malleable making complex shapes and curvature possible
- \* Large range of panel applications allowing for customisation
- \* Non-combustible building material. VMZINC is tested to **AS 1530.1- Combustibility test for building materials, components and structures'**. VMZINC material is non-combustible, with a spread of flame index of 0.
- \* Large range of surface finishes for both pre-weathered and natural zinc
- \* Weather resistant panel applications that have been internally and externally tested for wind resistance





# VMZINC Surface Finishes

Quartz-zinc®

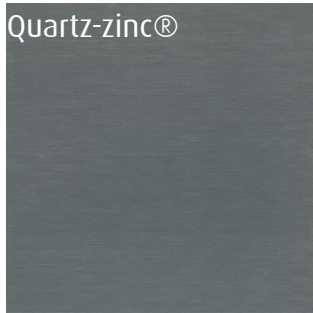

**Quartz-zinc®** is pre-weathered light grey zinc in the natural patina colour. When QUARTZ-ZINC is scratched, it will self-heal back to this same natural grey tone. The grey tones and grains of QUARTZ-ZINC blend well with other natural building materials.

Anthra-zinc®



**Anthra-zinc®** is the original black pre-weathered zinc which was first introduced by VMZINC in 1978. Anthra-zinc is manufactured by treating the surface of Natural Mill Finish zinc to give a stable and uniform black patina. The black is not a painted coating, though a durable black patina that is a similar appearance to slate and blends well with a range of surfaces.

**PIGMENTO®** is a coloured QUARTZ-ZINC® that can enhance a project's beauty while enriching the innovations of architectural design. The Standard range of PIGMENTO includes four shades: green, red, blue, and brown. The surface of QUARTZ-ZINC is glazed with mineral colour pigments to produce PIGMENTO. The visible and natural texture of QUARTZ-ZINC will remain. Remaining true to its origins, PIGMENTO maintains the random heterogeneity only a natural material can offer while its durable pigments can extend the QUARTZ-ZINC lifespan. Over time, the pigments of PIGMENTO will fade to reveal the natural beauty of QUARTZ-ZINC.

Pigmento Autumn Red®



Pigmento Ash Blue®



Pigmento Lichen Green®

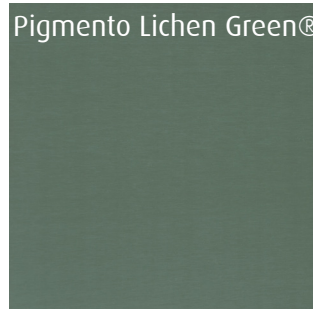

Pigmento Brown®

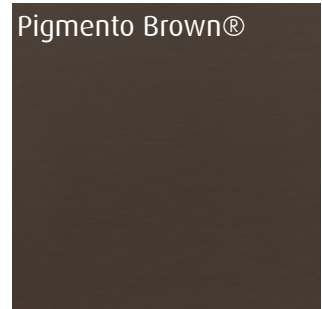

VMZINC has been manufacturing **Natural-Zinc** since 1837, and many of Paris' roofs are still clad in original VMZINC. Natural zinc is now available in a textured zinc, which is the very first engraved zinc on the market. Azengar, introduced in 2014 is Natural zinc with a unique rough surface texture adding a new dimension to Natural zinc.

Natural-Zinc



Azengar®





# VMZINC Ventilation rules

VMZINC Roof and façade systems are typically ventilated rainscreen systems. Failure to properly ventilate the roof or wall can lead to deterioration of the support substrate, mold and timber rot, leakages and possibly deterioration of the zinc. Proper management of condensation is extremely important and is strongly recommended by the Australian Building Codes Board for all sheet metal roof and wall cladding.

The support substrate is fixed over a cavity batten or top hat system, and air inlets at the high and low points allow for evacuation of humidity and drying of condensation and light water infiltration. This is achieved through perforated flashing strips at the top and bottom of wall (for facades), or at the ridge, eaves and gutters (for roofing).

For roofing VMZINC recommends a 19mm plywood support substrate for the zinc sheeting, with a 40mm continuous ventilation cavity. For facades 15mm plywood sheeting is recommended, with a 20mm continuous ventilation cavity.

For high humidity buildings other options can be considered. Please contact VMZINC directly and our professional design team can offer technical guidance for your project.

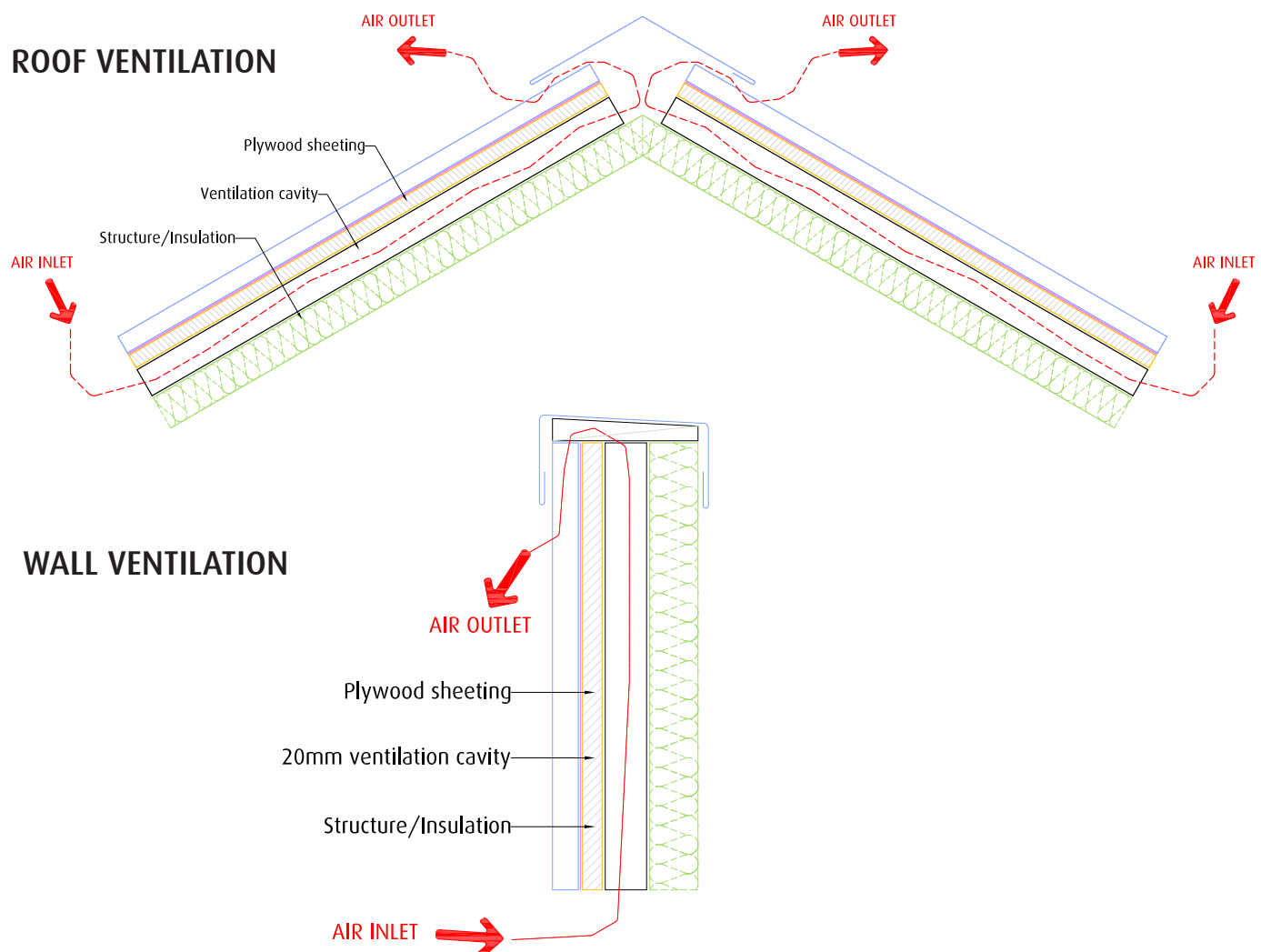



# VMZINC Double Lock Standing Seam roofing

VMZINC Double Lock Standing Seam is one of the most traditional zinc and metal roofing techniques. In zinc, standing seam panels can be adapted to almost any roof shape due to the high malleability of the metal. With roof slope as low as 3 degrees, a wide variety of designs including complex curvature can be achieved.

Main characteristics are:

- \* VMZINC Double Lock Standing Seam panels in VMZINC PLUS (backside coating)
- \* Low seam height (25mm)
- \* 600mm maximum panel width, 10-13 metres maximum panel length
- \* Installed over Breathable waterproofing membrane to a 19mm plywood substrate
- \* 40mm ventilation cavity (40mm cavity batten or top hat)
- \* Stainless steel fixing clips supplied by VMZINC. Both fixed and sliding clips available to properly manage thermal expansion
- \* Minimum roof slope 3 degrees

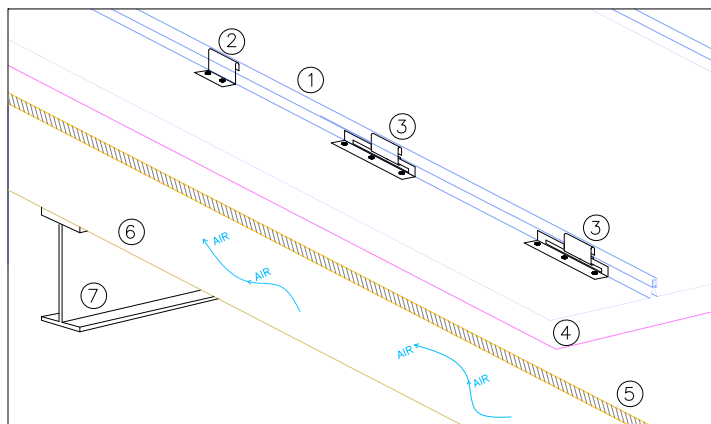
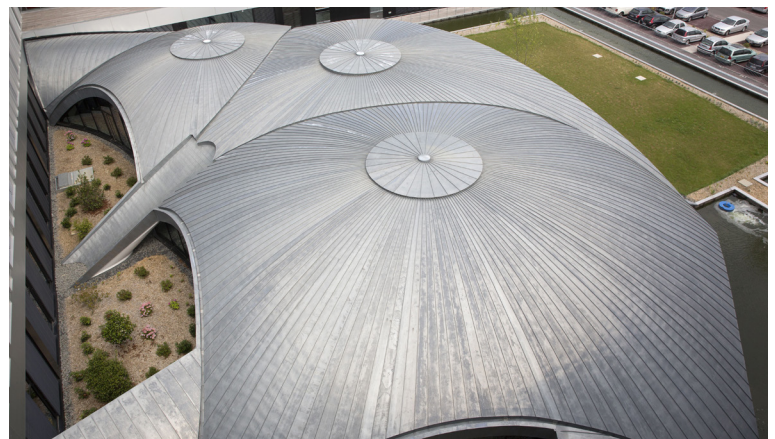
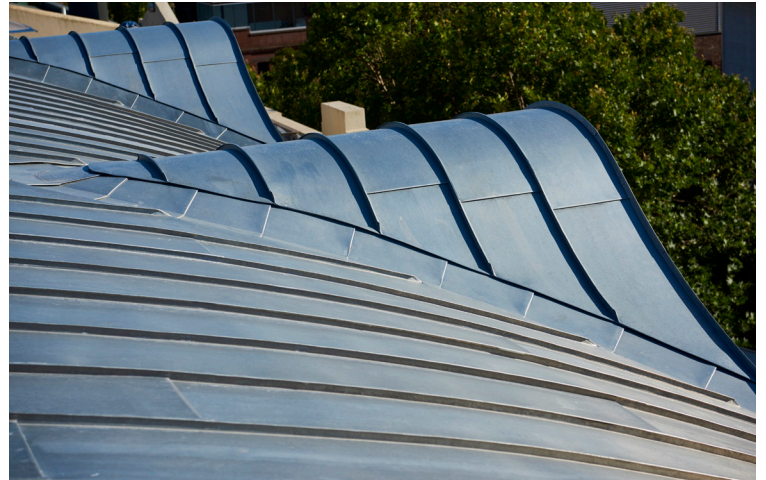

Legend:

1. VMZINC Double Lock Standing Seam panel
2. Stainless Steel fixed clip
3. Stainless Steel sliding clip
4. Breathable waterproofing membrane
5. 19mm plywood sheeting
6. 40mm ventilation cavity
7. Main structure

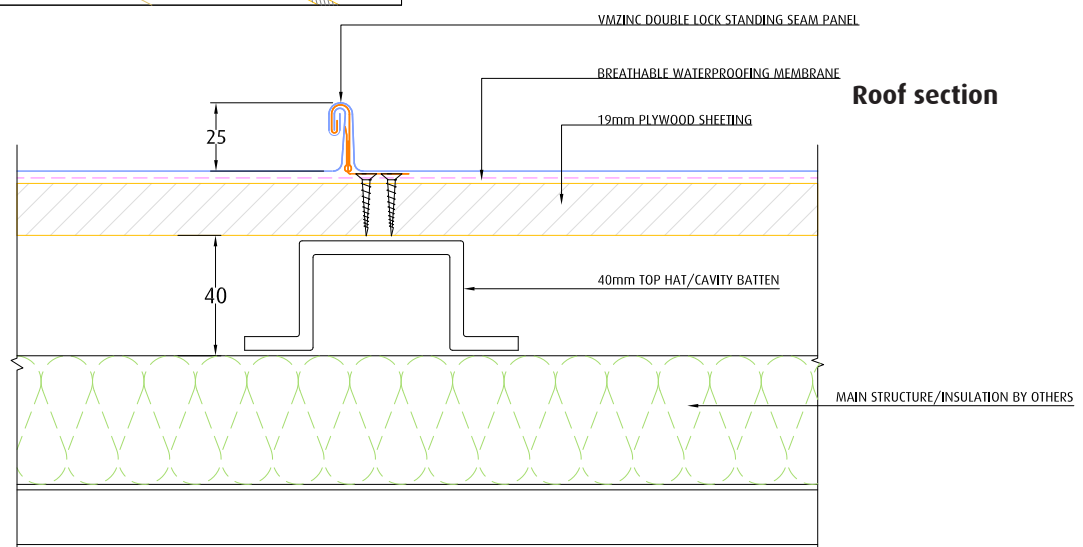



# VMZINC Adeka roofing and cladding

Adeka is VMZINC's exclusive pre-formed diamond shingle tile. This unique panel is supplied with a locking key integrated into the panel allowing for a secure water resistant finish, and a simple and quick installation. Adeka is suitable for both roofing and cladding.

Main characteristics are:

- \* VMZINC Adeka Diamond Shingle Tile (supplied with fasteners)
- \* 400mm x 400mm tile
- \* Pre-drilled holes for easy installation
- \* Polystyrene foam attached to backface of panel for rigidity
- \* Installed over a breathable waterproofing membrane to a plywood substrate (15mm for cladding, 19mm for roofing)
- \* Ventilation cavity (20mm for cladding, 40mm for roofing)
- \* 15 degree minimum slope for roofing

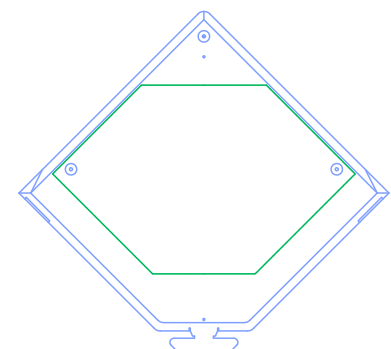
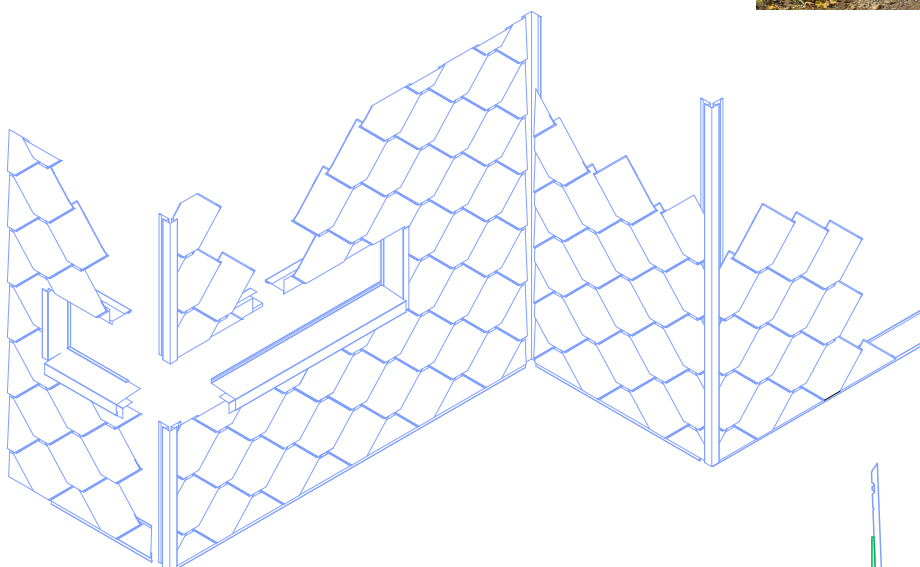



# VMZINC Single Lock Standing Seam cladding

VMZINC Single Lock Standing Seam for facades can be used for pitches between 60 and 90 degrees. Panels can be vertical, horizontal or diagonal and adapted to complex curvature.

Main characteristics are:

- \* VMZINC Single Lock Standing Seam panels in VMZINC PLUS (backside coating)
- \* Low seam height (25mm)
- \* 430mm maximum panel width (263mm, 180mm are also economical options), 4 metres maximum panel length, 2 metre for soffits
- \* Installed over a breathable waterproofing membrane to a 15mm plywood substrate
- \* 20mm ventilation cavity (20mm cavity batten or top hat)
- \* Stainless steel fixing clips supplied by VMZINC. Both fixed and sliding clips available to properly manage thermal expansion

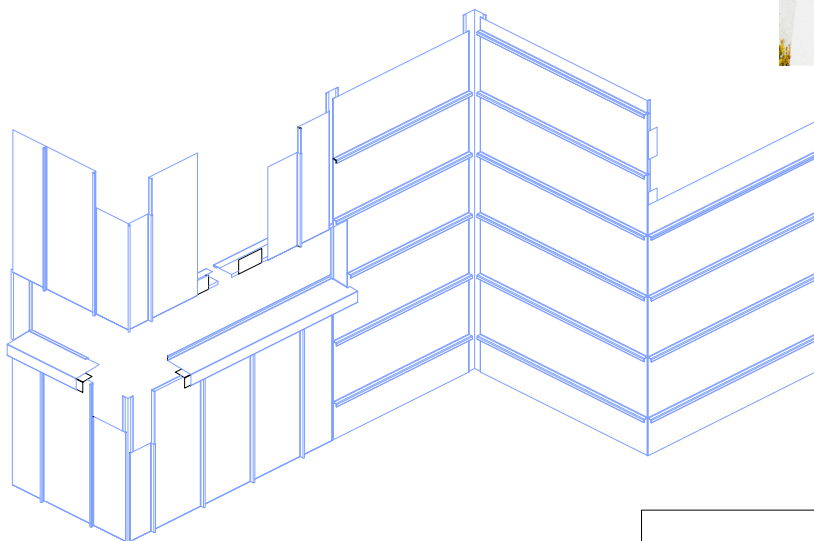

Wall section

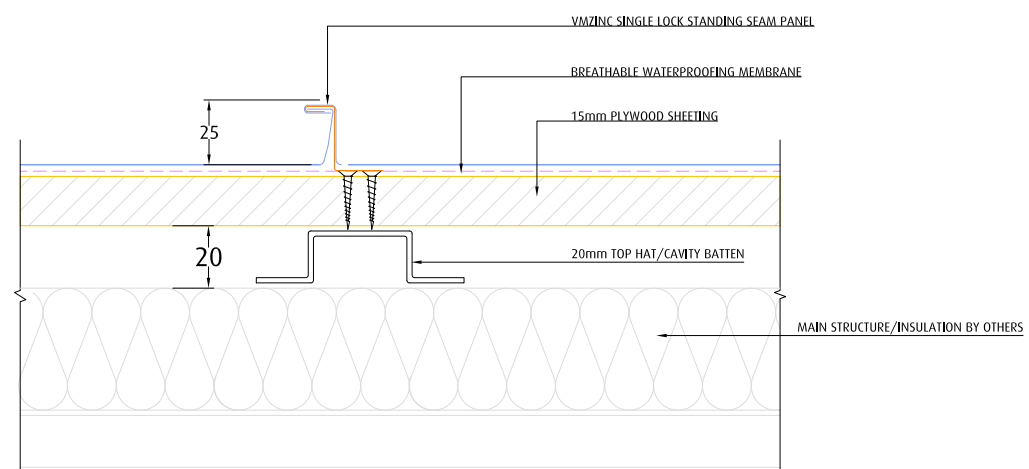



# VMZINC Interlocking Panel cladding

Interlocking Panels are one of the most popular VMZINC systems for façade. Panels are manufactured easily using profiling machines. Panels are connected with an interlocking groove giving a recessed shadow line joint. Interlocking Panels are fixed to steel framework (top hats or furring channels). The system is a rainscreen facade system with a ventilated cavity safeguarding the wall from condensation and light water infiltration.

Main characteristics are:

- \* VMZINC 1mm Interlocking Panels (NON PLUS)
- \* Interlocking shadow line joint (10-15mm recommended)
- \* Panels are 24mm deep
- \* 300mm, 250mm, 200mm panel widths. Irregular panel widths can also be achieved.
- \* Maximum panel length/height is 4 metres, maximum 2 metres for soffits
- \* Panels supported by galvanised steel or aluminium top hats or furring channel
- \* 20mm ventilation cavity

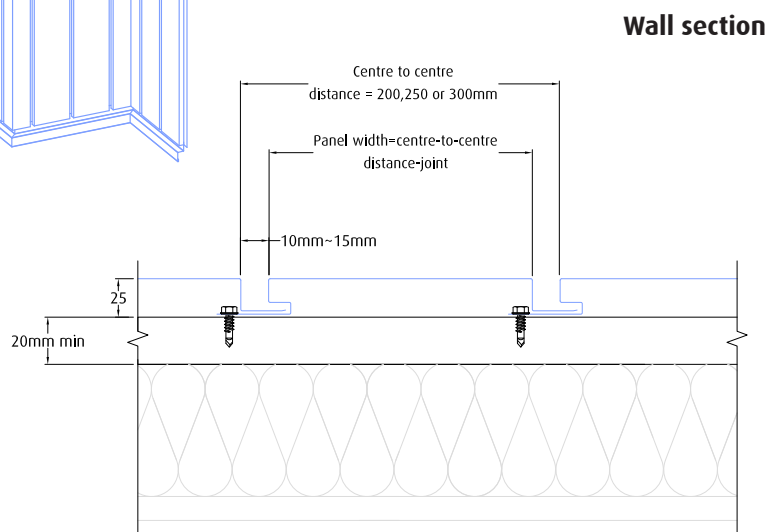
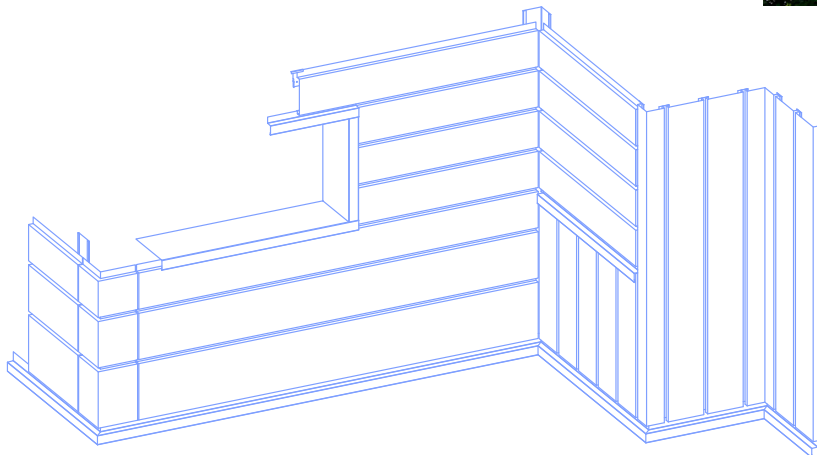

# VMZINC Flat Lock Panel cladding

Flat Lock Panels are one of the most traditional facade systems, often referred to as 'Shingle' panels. Panels have folded edges on all 4 sides and are connected with concealed fixing clips. Recessed shadow joints or overlapped joints can be achieved.

Main characteristics are:

- \* VMZINC Flat Lock Panels in VMZINC PLUS (backside coating)
- \* Recessed shadow joints, or overlapped joints
- \* Maximum 375mm wide panels (recessed joint), or 400mm wide panels (overlapped joint) are recommended
- \* 3 metres maximum length/height, maximum 2 metres for soffits
- \* Installed over a breathable waterproofing membrane to a 15mm plywood substrate
- \* 20mm ventilation cavity (20mm cavity batten or top hat)
- \* Fixing clips from galvanised steel or VMZINC material

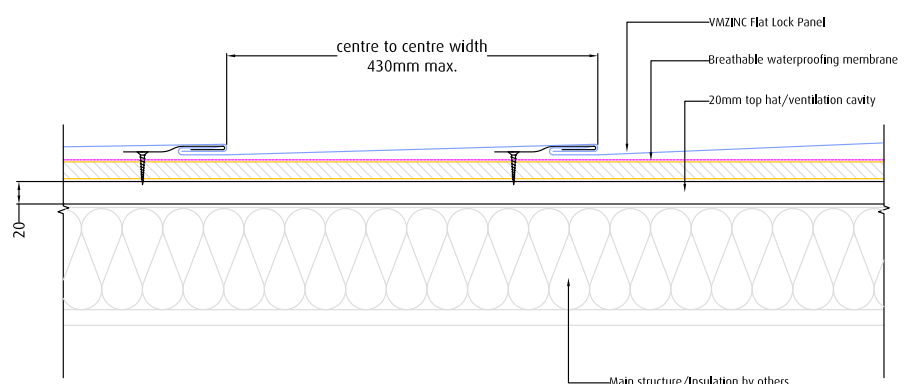
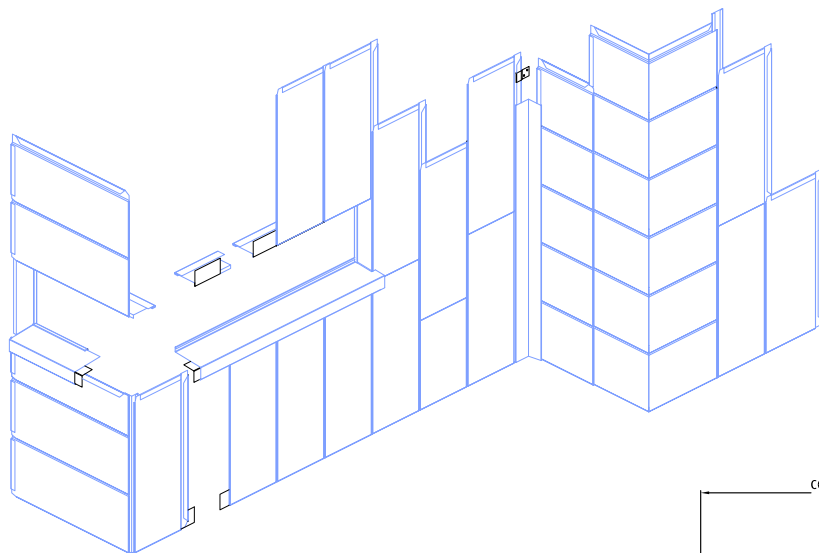



# VMZINC Sine Wave cladding

VMZINC Sine Wave (corrugated panels) allow for an easy installation of a traditional facade method in an extremely durable and low maintenance building material.

Main characteristics are:

- \* VMZINC 0.80mm or 1mm thick material
- \* Typical coverage is 760mm width, with a maximum span of 6 metres
- \* Panels are installed over steel subframing (galvanised steel/ aluminium top hats/furring channel)
- \* 20mm ventilation cavity

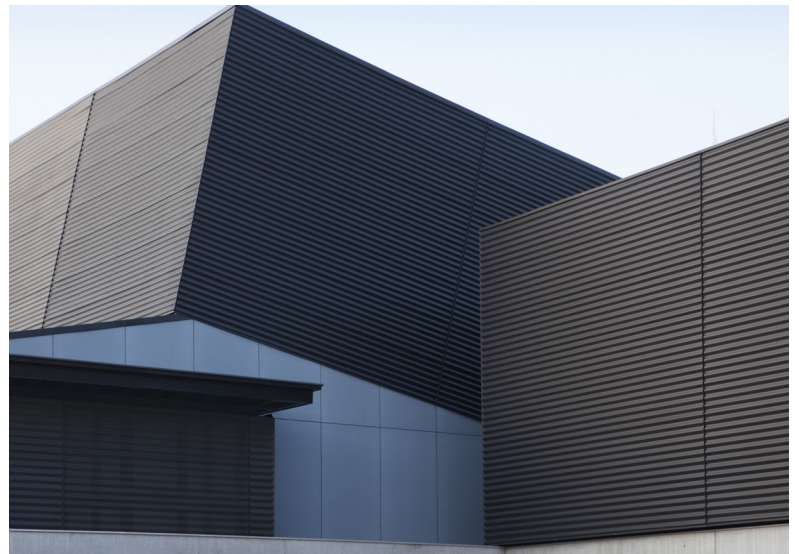
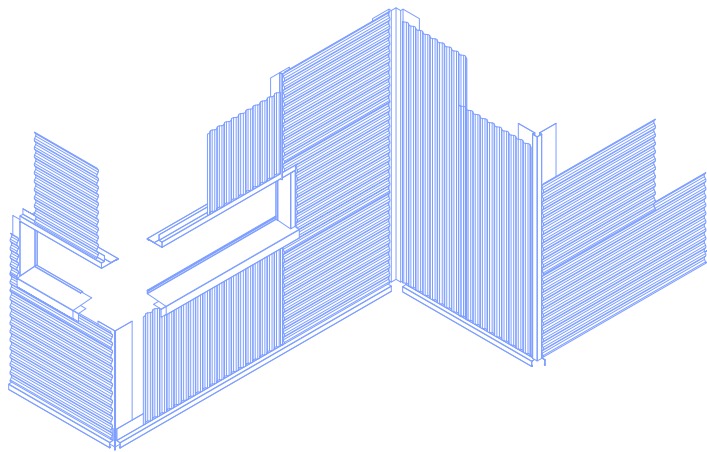

**Sine Wave Panels**

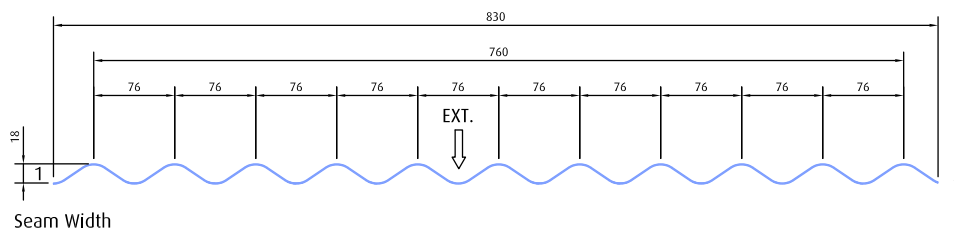
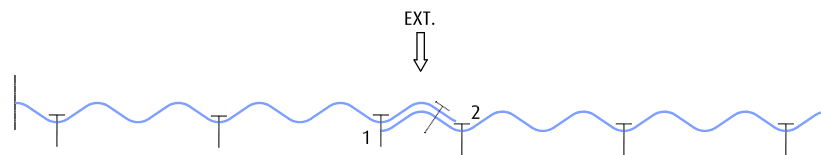

# VMZINC PLUS®

VMZ Zinc Plus® is an exceptional product which combines our high quality rolled zinc titanium alloy with a long lasting and high density coating applied to protect the underside of the material from corrosion.

VMZ Zinc Plus® is available in all aspects in 0.70mm and 0.80mm thickness (Natural Zinc , Azengar®, ANTHRA-ZINC®, QUARTZ-ZINC® and PIGMENTO®).

This innovative product extends the capabilities of regular VMZ Zinc in the following ways:

It makes installation possible on roof decking made of incompatible materials, like plywood or other treated timbers. It makes installation possible in a “warm roof” application where the underside of the zinc and support are not ventilated. VMZ Zinc Plus® can be bent, folded or profiled without any surface changes, thus allowing the use of identical installation methods to VMZ non-plus.

## How is it made?

To create VMZ Zinc Plus®, a 60 micron thick coating is applied to the underside of the zinc. The type of coating used and its thickness are important factors in the durability of this product.

The coating is a light grey or white colour.

## Incompatible substrates

Some materials are not compatible with zinc.

For instance, woods with a pH of less than 5 must be avoided since they can have a corrosive effect on zinc in the presence of humidity.

Plywood can be problematic since it can be composed of acidic wood species or may contain tannins or phenolic glues.

VMZ Zinc Plus® safely isolates the zinc and allows for exceptional durability without the need to install a separation membrane between the support and zinc.



# VMZINC Compatibility

## Zinc and Other Products

Certain products when placed in contact with zinc can have detrimental effects on the appearance and/or structural integrity of the zinc. Acidic products and products that can generate a galvanic reaction must not be used with zinc. Also, run off from incompatible products onto zinc must be avoided.

### \* Zinc in relation with timber

A low or non-acid solid, natural and non treated timber deck, that is, with a pH of between 5 and 7 is compatible with zinc and can be used in direct contact with zinc.

Compatible timber	Incompatible timber
Pine	Larch
Spruce	Oak
Poplar	Chestnut
	Red Cedar
	Douglas Fir
	White Cedar
	Gum tree
	All wood varieties with PH < 5

### \* Zinc in relation with other metals

Contact between zinc and other metals must take into account the electro-chemical reactions caused by a difference in electrical potential between the surfaces of the metals. Therefore, a certain number of metals are acceptable whilst others must be avoided.

Compatible metals	Incompatible metals
Lead	Copper
Aluminium	Steel (un-galvanised)
Galvanised steel	
Stainless steel	

# VMZINC Compatibility

\* Zinc in relation with glues and mastics

Table of glues and mastics	
compatible products	incompatible products
Polyurethanes	Acid epoxides
Non-acetic silicones	Ureas / melanin / phenol-formaldehyde (wood or panel gluing)
MS Polymers	Acrylics (depending on the reagent used)





# VMZINC Maintenance

## \* Dirt

If dirt accumulates on the zinc during the installation process, it should be gently removed with a clean/dry cloth or with warm water and mild soap. Do not use cleaning products to remove dirt.

Please consult with our Sales Team for cleaning procedures.

## \* Grease and oily marks

In case of grease or oily marks, use acetone to remove them. Acetone is a volatile product, so please: wait for good weather as the zinc panels have to be perfectly dry and cool – don't wait for hot temperatures as heat is not good with acetone. Clean the whole panel with a very clean cotton cloth - don't scratch the zinc.

**Always do a test sample before cleaning a surface.**

## \* Scratches

If a scratch appears during the installation process, the self-healing patina will minimise the effects of the scratch over time. If the scratch is especially deep or wide then the panel may need to be replaced. Generally, scratches are expected and are self-correcting.

## \* Fingerprints

Fingerprints can be noticeable on wall applications. Because of the "self-healing" nature of zinc, fingerprints will be obscured by the formation of the patina over time. To remove them quickly, use mineral oil available from VMZINC. Some mineral oils may react adversely to the zinc, so be sure to use only VMZINC® specified mineral oil.

## \* Salt Deposits

Zinc has been successfully used in marine environments for several decades.

In some marine climates, the salt in the air or water reacts with zinc to form zinc oxychloride, which has a whitish appearance. This white residue will normally be washed away by rainfall. However, in drier marine environments, it may remain on the surface.

Salt deposits will tend to develop near the shore on zinc soffits and other protected areas of a building such as, but not limited to eave flashing, gutter underside etc. Water naturally condenses and then evaporates from zinc surfaces leaving some salts. Spray also contributes to this condition. While salt deposits are not harmful to the zinc, white marks appear over time. **This is a natural occurrence and VMZINC cannot be held responsible for the appearance of salt deposits on zinc surfaces.**

If you are planning to install VMZINC on the sea front; please, consult with our Sales Team.

# VMZINC Maintenance

## \* Colour variations

Zinc is a natural material. Slight colour variations between panels are common and expected.

However, the colour difference will be minimized over time by the continuous formation of the protective patina. Patina formation will vary depending on the location of the building and weather conditions.

Colour variations in QUARTZ-ZINC® should not present a problem in the long run when the material is exposed to the atmosphere. The patina process will form a uniform colour throughout the continuous zinc plane over time. This patina formation takes on average between 2 to 5 years (except in dry climates where it takes longer).

To ensure a consistent finish we recommend profiling and installing the components of a new project using coils from the same batch. More considerations need to be taken when installing the Pigmento® range (please consult with our sales team).

VMZINC recommends to always obtain a product sample from the installing company prior to installation.

Aesthetic criteria are by nature subjective, non warranted and related to each market. Pictures and samples may vary versus the finish of the project site. The colour finish options and coating longevity may also vary due to the location of the site, as it is dependant on the environment.

## \* Flatness

A distinctive advantage of zinc is its malleability. The inherent softness of the material and its ductility allow it to be shaped into almost any form. Some waviness especially with low thickness may occur and can be more apparent during certain times of the day, based upon the angle at which the sunlight hits the cladding or the roof. This is the intrinsic characteristic of the zinc and is part of the aesthetic appearance of the material.

## Expansion of VMZINC

Any work involving VMZINC must allow it to expand and contract freely. The linear expansion of VMZINC is 0.022 mm per meter and per degree centigrade.

Example: In Sydney, the temperature range to bear in mind is from 0°C in mid-winter to + 90°C on the surface of the metal in the sun at the height of the summer. Assuming an ambient temperature of 25°C during installation, we have to take into account an additional 65°C (expansion) 25°C less (contraction).

For a 10 meter long panel:

A. anticipate an  $0.022 \text{ mm} \times 10 \times 65 = 14.30 \text{ mm}$  increase in length,

B. anticipate  $0.022 \text{ mm} \times 10 \times 25 = 5.5 \text{ mm}$  contraction.



## Zinc Aesthetics

It is generally not recommended that zinc roofs and walls are cleaned as rain water performs this task very well. Non-rinsed surfaces such as soffits and some facades, especially in coastal areas may exhibit some stains. It should be noted that this is not a form of corrosion.

Zinc can be installed adjacent to limestone. The run off from limestone onto zinc material is acceptable. However, limestone dust and gypsum dust generated during cutting operations can react with zinc in the presence of water and form a superficial layer of white rust. No dust should be in contact with unprotected zinc. To prevent white rust, good construction practices should be used to limit the amount of dust that comes in contact with the zinc.

VMZINC manufacturing uses a colour management system based on the Y-Factor. The Y-factor ranges from 0 to 100: 0 is black and 100 is white. The range for ANTHRA-ZINC is 5 to 7 and the range for QUARTZ-ZINC is 22 to 25. We recommend that one project uses one production batch.

## Waterproofing Membranes

VMZINC recommends a breather layer to the underside that allows water vapour to pass through it, but is water proof to liquid. A vapour barrier is not recommended between zinc and plywood because this will trap moisture to the underside of the metal and can lead to underside corrosion.

Bituminous membranes are prohibited for use in direct contact with zinc because of the risk of water being retained. This constitutes a corrosion risk since the water cannot be removed from the felt.

The issue is also with ageing of Bitumen when constantly exposed to high temperatures, which leads to Bitumen oxidation. In this case water mixed with Bitumen becomes acidic and corrosive to zinc and its protective coatings.

## Fire Resistance

VMZINC was tested in accordance with 'AS 1530.1- Combustibility test for building materials'. VMZINC material is non-combustible.

Zinc roof and facade systems can be installed with a steel subframe in place of the plywood substrate for building requiring non-combustible construction. If more information on this topic is required, please contact VMZINC directly.

## Solar Reflectance and Solar Absorbance

VMZINC material has low reflectivity compared to other building metals due to the matte surface texture of zinc patina. Furthermore, this reflectivity is predominantly diffuse reflectivity (not specular). Diffuse reflectivity is less obtrusive than specular reflectivity because when light hits a surface with only specular reflectivity, it is reflected back in multiple directions rather than directly back. Your reflection cannot be seen on a surface with diffuse reflectivity and this applies to weathered zinc with its matte surface.

Solar reflectivity of zinc with patina is always around 20%, though drops after installation to below 20% as the natural patina continually redevelops.

# VMZINC Weights and thicknesses



VMZINC Weights and Thicknesses		
Thickness	Gauge	Weight
1.5mm	16	(10.8kg/sq. meter)
1.0mm	20	(7.2kg/sq. meter)
0.8mm	22	(5.76kg/sq. meter)
0.7mm	24	(5.04 kg/sq. meter)



This document is intended for specifiers (building project and architect and design teams) and users (companies responsible for installation on the building site) of the designated product or system.

Its purpose is to provide the main information, text and diagrams, relating to specification and installation (including supporting structures) and flashing installation. Any use of specification outside the area and/or specifications contained in this manual requires specific consultation with the VMZINC technical departments. This does not commit the latter to any responsibility with regard to the feasibility of the design or implementation of these projects.

#### **Countries of application**

This document applies exclusively to the specification and installation of the designated products or systems on building sites in Australia and New Zealand.

#### **Qualifications and reference documents**

Please note that the specification of all the construction systems for a given building remains the exclusive responsibility of its design team, who must, in particular, ensure that the specified products are suitable for the purpose of the building and compatible with the other products and techniques used.

Please note that the correct use of this manual requires knowledge of VMZINC materials and of the zinc roofing profession.

While construction is underway all standards in force must be respected. Furthermore, VMZINC offers training courses specifically for professionals.

#### **Responsibility**

The specification and installation of VMZINC products are the sole responsibility of the architects and building professionals who must ensure these products are used in a way suited to the end purpose of the construction and that they are compatible with the other products and techniques used.

The specification and installation of the products implies respecting the standards in force and the manufacturer's recommendations. In this regard, VMZINC publishes and regularly updates specifications and installation manuals for specific geographic areas and provides training courses. All the information on the latter can be obtained from the local VMZINC team.

Unless otherwise agreed in writing, VMZINC cannot be held responsible for any damages resulting from a specification or installation that does not respect all of VMZINC's specifications and the above standards and practices.